

Stirling, Shark, Caspian, and Mayfair Shower/Bath – Steel Bath Installation

9.01.1

1. Protect the bath from accidental damage in handling and installation. Check the porcelain enamel surface carefully on removal of packaging materials prior to and again after installation.
2. **Accurate setout for the bath waste is essential.** Set out the pipe work for the bath and check the alignment with the waste before installation.
3. Build in the bath support structure as detailed below for timber, steel or masonry installations and grade bath sub-floor to local Authorities requirements.
4. The bath **must** be supported continuously and evenly under the entire rim and the bath rim support must positively locate the bath, plumbing connections must not be used to restrain the bath against movement. (See detail below).
5. **Metal Pipe work Installation:** To avoid damage to the porcelain enamel surface forces must not be applied to the bath by excessively rigid pipe work or misaligned pipe work. **Do not support the bath with the pipe work.** Metal waste pipe work must incorporate a suitable flexible coupling equivalent to that shown in detail below which will accommodate a slight misalignment. For trap installations above the floor level ensure that the bottom of the trap or pipe work has a minimum 10mm clearance from the floor level below the bath. (See detail below).
6. **Plastic waste pipe work Installation:** To avoid damage to the porcelain enamel surface forces must not be applied to the bath by excessively rigid pipe work or misaligned pipe work. **Do not support the bath with the pipe work.** Plastic waste pipe work **must** be unrestrained for a length of 300mm from the waste outlet fitting or a flexible coupling used. (See detail below). For trap installations above the floor level ensure the bottom of the pipe work has a 10mm clearance from the floor. (See detail below).
7. Before enclosing and tiling the bath, ensure that all the connections and pipe work are watertight. Ensure that the bath drains fully prior to completion of installation. The air space beneath the bath should be ventilated to the requirements of local Authorities.
8. Apply an approved flexible sealant to all exposed edges.
9. Enclose and tile in bath.

Cleaning and Maintenance.

Use only neat detergent or non-abrasive cream cleanser as recommended by the manufacturer for porcelain enamel. Apply on a soft cloth and hand rinse clean. If the bath has an optional "Sure Step" surface, clean it with a stiff polyester or nylon brush as well as with liquid cleaning detergents.

After cleaning the bath or adjacent tiles, or using bath salts, always rinse the bath clean with water to remove any chemical residues.

Do not use an abrasive cleaner to remove surface grime.

Note: Caroma products, treated with care, will ensure many years of satisfactory service. Avoid contact with sharp objects and do not drop heavy or hard objects onto the surface. Always fill the bath before the addition of acidic / or alkaline bath salts.

Installation Detail for Built-in Baths

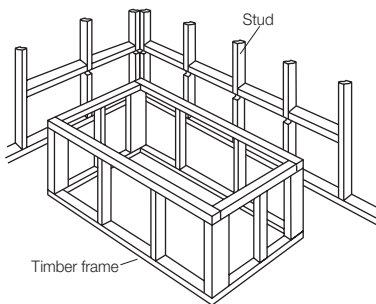
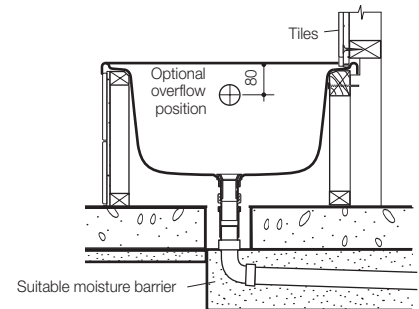
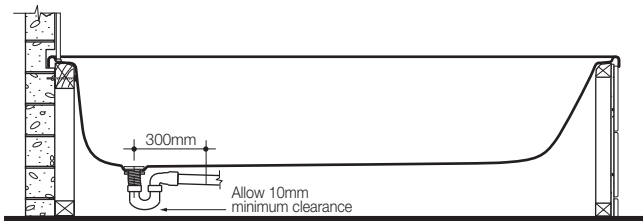

IMPORTANT NOTICE FOR INSTALLATIONS:

1. Clearance must be maintained under the bath to allow free flexing of the entire bottom of the bath or shower.
2. Do not use offset connectors.
3. Ensure no misalignment of waste fitting that may cause twisting of the bath waste. (ie there are no vertical forces acting on the waste pipe connecting to the bath).
4. Compliance with AS.3740 Waterproofing of wet areas within residential buildings applies when installing baths.

Timber or Steel Stud Wall Installation

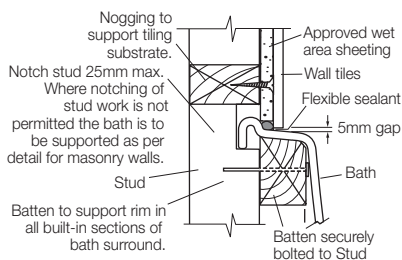

Masonry Wall Installation

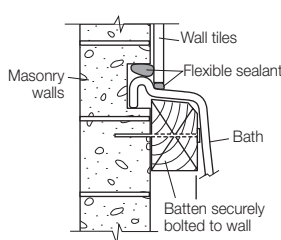

Timber or Steel Frame Support Installation

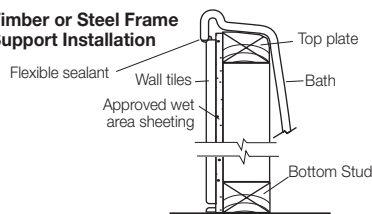

Optional Pop-up Waste and Overflow Kit

Available for all models of Stirling, Caspian and Shark baths.
Code No.857891.

Timber to comply with AS1684

Flexible Coupling Assembly Detail A

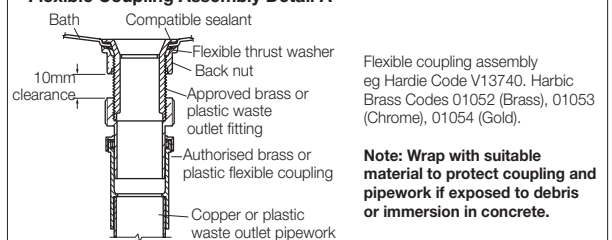

Flexible coupling assembly eg Hardie Code V13740. Harbic Brass Codes 01052 (Brass), 01053 (Chrome), 01054 (Gold).

Note: Wrap with suitable material to protect coupling and pipework if exposed to debris or immersion in concrete.

Assembly Detail B

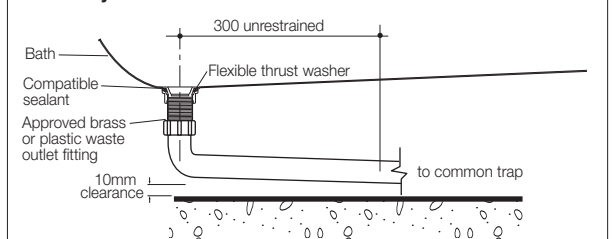

Assembly Detail C

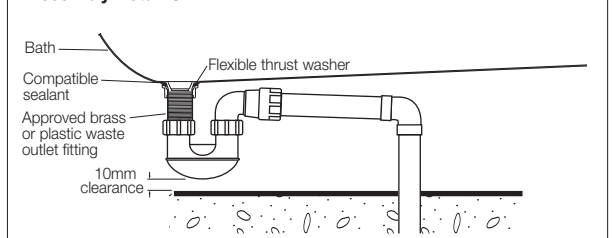

Starlett Baths - Steel Bath Island Installation

1. Protect the bath from accidental damage in handling and installation. Check the porcelain enamel surface carefully on removal of packaging materials prior to and again after installation.
2. **Accurate setout for the bath waste is essential.** Set out the pipe work for the bath and check the alignment with the waste before installation.
3. Build the bath support structure as detailed below for timber, steel or masonry installations and grade bath sub-floor to local Authorities requirements.
4. The bath **must** be supported continuously and evenly under the entire rim and the bath rim support must positively locate the bath, plumbing connections must not be used to restrain the bath against movement. (See detail below.)
5. **Metal Pipe Work Installation:** To avoid damage to the porcelain enamel surface forces must not be applied to the bath by excessively rigid pipe work or misaligned pipe work. **Do not support the bath with the pipe work.** Metal waste pipe work must incorporate a suitable flexible

coupling equivalent to that shown in detail below which will accommodate a slight misalignment. For trap installations above the floor level ensure that the bottom of the trap or pipe work has a minimum 10mm clearance from the floor level below the bath. (See detail below.)

6. **Plastic Pipe Work Installation:** To avoid damage to the porcelain enamel surface forces must not be applied to the bath by excessively rigid pipe work or misalign pipe work. **Do not support the bath with the pipe work.** Plastic waste pipe work **must** be unrestrained for a length of 300mm from the waste outlet fitting or a flexible coupling used. (See detail below). For trap installations above the floor level ensure that the bottom of the trap or pipe work has a minimum 10mm clearance from the floor level below the bath. (See detail below.)
7. Before enclosing and tiling the bath, ensure that all the connections and pipe work are watertight. Ensure that the bath drains fully prior to completion of installation. The air space beneath the bath should be ventilated to the requirements of local Authorities.

8. Apply an approved flexible sealant to all exposed edges.
9. Enclose and tile in bath.

Cleaning and Maintenance.

Use only neat detergent or non-abrasive cream cleanser as recommended by the manufacturer for porcelain enamel. Apply on a soft cloth and hand rinse clean. If the bath has an optional "Sure Step" surface, clean it with a stiff polyester or nylon brush as well as with liquid cleaning detergents.

After cleaning the bath or adjacent tiles, or using bath salts, always rinse the bath clean with water to remove any chemical residues.

Do not use an abrasive cleaner to remove surface grime.

Note: Caroma products, treated with care, will ensure many years of satisfactory service. Avoid contact with sharp objects and do not drop heavy or hard objects onto the surface. Always fill the bath before the addition of acidic / or alkaline bath salts.

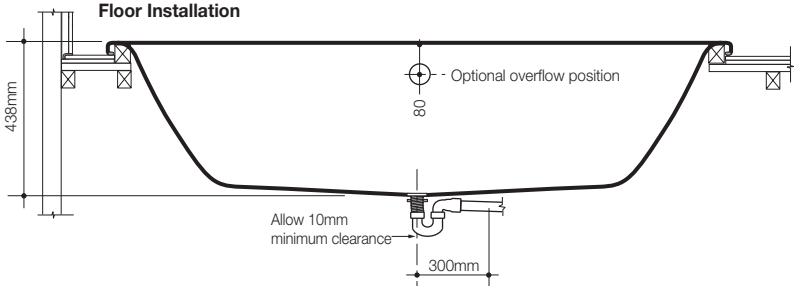
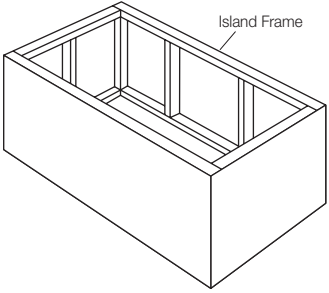
IMPORTANT NOTICE FOR INSTALLATIONS:

1. Clearance must be maintained under the bath to allow free flexing of the entire bottom of the bath or shower.
2. Do not use offset connectors.
3. Ensure no misalignment of waste fitting that may cause twisting of the bath waste. (ie there are no vertical forces acting on the waste pipe connecting to the bath).
4. Compliance with AS.3740

Waterproofing of wet areas within residential buildings applies when installing baths.

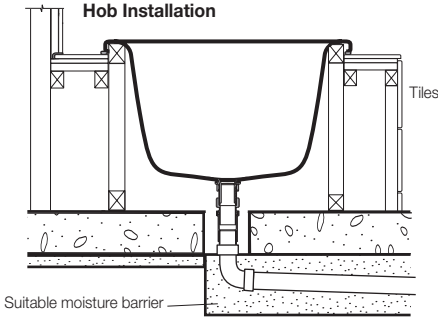

Island Installation for floor mounted bath

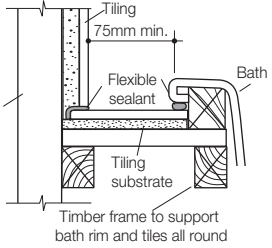

Granite and Marble Installations

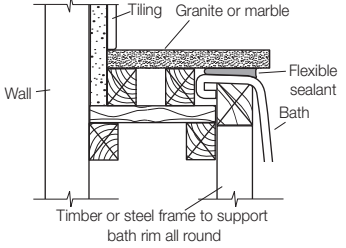

For Granite or Marble Installations
The granite or stone should be independently supported, and at no time should the granite come in contact with the bath.

Optional Pop-up Waste and Overflow Kit
Available for both models of Starlett baths.
Code No.857891.

Flexible Coupling Assembly Detail A

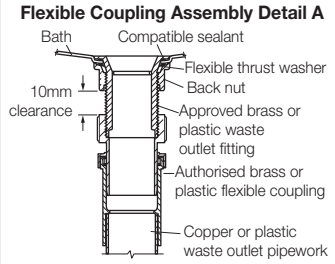

Flexible coupling assembly
eg Hardie Code V13740, Harbic Brass Codes 01052 (Brass), 01053 (Chrome), 01054 (Gold).

Note: Wrap with suitable material to protect coupling and pipework if exposed to debris or immersion in concrete.

Island Installation for hob mounted bath

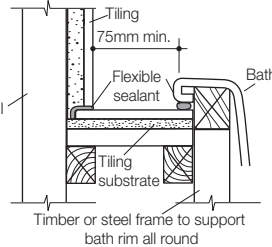

Assembly Detail B

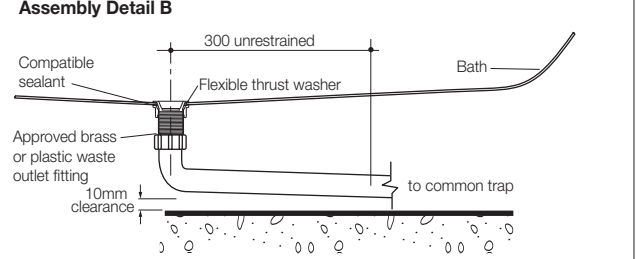

Assembly Detail C

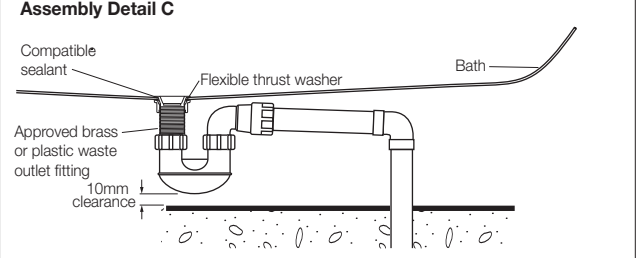

Caroma Industries Limited ABN 35 000 189 499

Sales Offices in all States.

Marina Baths - Steel Bath Island Installation

1. Protect the bath from accidental damage in handling and installation. Check the porcelain enamel surface carefully on removal of packaging materials prior to and again after installation.
2. **Accurate setout for the bath waste is essential.** Set out the pipe work for the bath and check the alignment with the waste before installation.
3. Build the bath support structure as detailed below for timber, steel or masonry installations and grade bath sub-floor to local Authorities requirements.
4. The bath **must** be supported continuously and evenly under the entire rim and the bath rim support must positively locate the bath, plumbing connections must not be used to restrain the bath against movement. (See detail below.)
5. **Metal Pipe Work Installation:** To avoid damage to the porcelain enamel surface forces must not be applied to the bath by excessively rigid pipe work or misaligned pipe work. **Do not support the bath with the pipe work.** Metal waste pipe work must incorporate a suitable flexible coupling equivalent to that shown in detail below

which will accommodate a slight misalignment. For trap installations above the floor level ensure that the bottom of the trap or pipe work has a minimum 10mm clearance from the floor level below the bath. (See detail below.)

6. **Plastic Pipe Work Installation:** To avoid damage to the porcelain enamel surface forces must not be applied to the bath by excessively rigid pipe work or misalign pipe work. **Do not support the bath with the pipe work.** Plastic waste pipe work **must** be unrestrained for a length of 300mm from the waste outlet fitting or a flexible coupling used. (See detail below). For trap installations above the floor level ensure that the bottom of the trap or pipe work has a minimum 10mm clearance from the floor level below the bath. (See detail below.)
7. Before enclosing and tiling the bath, ensure that all the connections and pipe work are watertight. Ensure that the bath drains fully prior to completion of installation. The air space beneath the bath should be ventilated to the requirements of local Authorities.

8. Apply an approved flexible sealant to all exposed edges.
9. Enclose and tile in bath.

Cleaning and Maintenance.

Use only neat detergent or non-abrasive cream cleanser as recommended by the manufacturer for porcelain enamel. Apply on a soft cloth and hand rinse clean. If the bath has an optional "Sure Step" surface, clean it with a stiff polyester or nylon brush as well as with liquid cleaning detergents.

After cleaning the bath or adjacent tiles, or using bath salts, always rinse the bath clean with water to remove any chemical residues.

Do not use an abrasive cleaner to remove surface grime.

Note: Caroma products, treated with care, will ensure many years of satisfactory service. Avoid contact sharp objects and do not drop heavy or hard objects onto the surface. Always fill the bath before the addition of acidic / or alkaline bath salts.

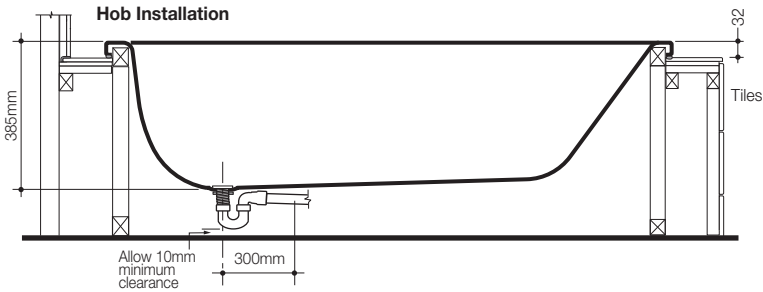
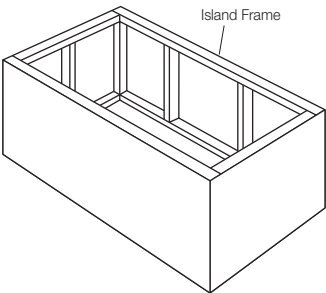
Island Frame

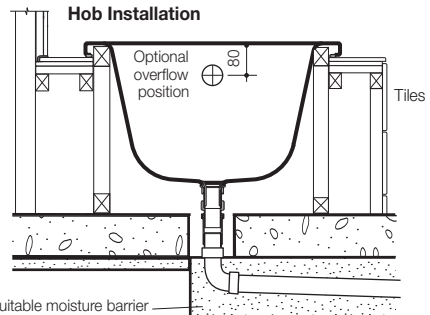

IMPORTANT NOTICE FOR INSTALLATIONS:

1. Clearance must be maintained under the bath to allow free flexing of the entire bottom of the bath or shower.
2. Do not use offset connectors.
3. Ensure no misalignment of waste fitting that may cause twisting of the bath waste. (ie there are no vertical forces acting on the waste pipe connecting to the bath).
4. Compliance with AS.3740 Waterproofing of wet areas within residential buildings applies when installing baths.

Granite and Marble Installations

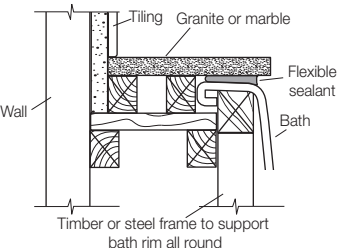

Timber or steel frame to support bath rim all round

For Granite or Marble Installations The granite or stone should be independently supported, and at no time should the granite come in contact with the bath.

Island Installation for hob mounted bath

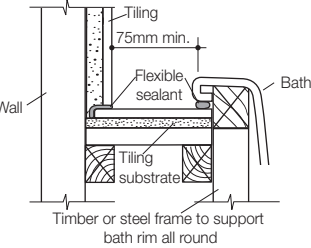

Timber or steel frame to support bath rim all round

Optional Pop-up Waste and Overflow Kit
Code No.857891.

Flexible Coupling Assembly Detail A

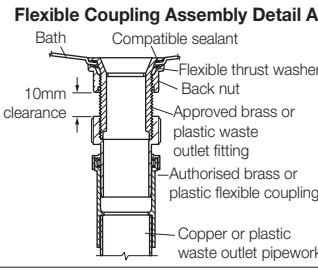

Flexible coupling assembly eg Hardie Code V13740. Harbic Brass Codes 01052 (Brass), 01053 (Chrome), 01054 (Gold).

Note: Wrap with suitable material to protect coupling and pipework if exposed to debris or immersion in concrete.

Assembly Detail B

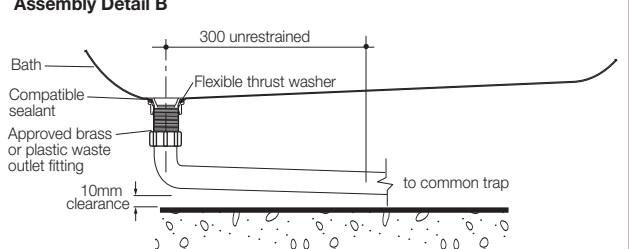

Assembly Detail C

